

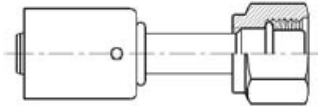

XII. Fittings



Straight Female O-Ring

Standard Barrier	Reduced Barrier	THREAD	F	H	PORT
27-2840	27-8272	5/8"-18	6	6	-
27-1266	27-2861	3/4"-16	8	8	-
27-1267	27-3006	7/8"-14	10	10	-
27-1316	NS	1-1/16"-14	12	12	-
27-1315	27-3684	5/8"-18	6	8	-
27-2431	NS	3/4"-16	8	10	-
27-1268	27-3901	7/8"-14	10	12	-
27-1454	NS	3/4"-16	8	6	-

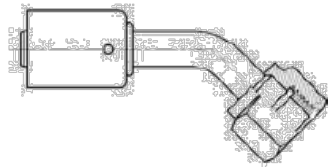

45° Female O-Ring

Standard Barrier	Reduced Barrier	THREAD	F	H	PORT
27-1255	27-2962	5/8"-18	6	6	-
27-1256	27-2862	3/4"-16	8	8	-
27-1257	NS	7/8"-14	10	10	-
27-1314	NS	1-1/16"-14	12	12	-
27-2583	NS	3/4"-16	8	10	-
27-1071	NS	7/8"-14	10	12	-

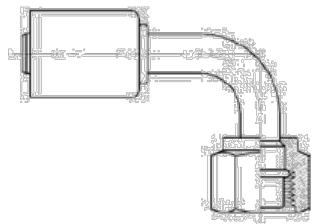

90° Female O-Ring

Standard Barrier	Reduced Barrier	THREAD	F	H	PORT
27-1285	27-2947	5/8"-18	6	6	-
27-1286	27-2172	3/4"-16	8	8	-
27-1287	27-2195	7/8"-14	10	10	-
27-1317	NS	1-1/16"-14	12	12	-
27-2096		5/8"-18	6	8	-
27-2239	NS	3/4"-16	8	10	-
27-1288	NS	7/8"-14	10	12	-
27-2922		3/4"-16	8	6	-
27-3584	NS	1-1/16"-14	12	10	-

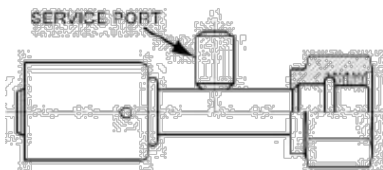

Straight Female O-Ring With Switch or Service Port

Standard Barrier	Reduced Barrier	THREAD	F	H	PORT
NS	27-3605	5/8"-18	6	6	1/4" R12
27-1275	27-2964	5/8"-18	6	6	16mm R134a
27-1276	27-2976	3/4"-16	8	8	16mm R134a
27-1277	27-2953	7/8"-14	10	10	13mm R134a
27-2083	27-3900	7/8"-14	10	12	13mm R134a

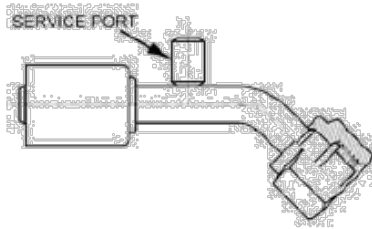

45° Female O-Ring With Switch or Service Port

Standard Barrier	Reduced Barrier	THREAD	F	H	PORT
NS	27-2950	5/8"-18	6	6	1/4" R12
27-2102	27-2975	3/4"-16	8	8	16mm R134a
27-2884	27-2911	7/8"-14	10	10	13mm R134a
27-2103	27-2979	7/8"-14	10	12	13mm R134a

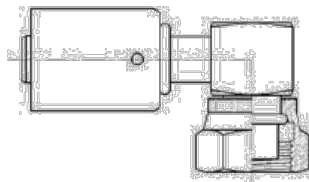

90° Female O-Ring Short Drop

Standard Barrier	Reduced Barrier	THREAD	F	H	PORT
27-2328		3/4"-16	8	8	-
27-2329		7/8"-14	10	10	-
27-4085		7/8"-14	10	12	-

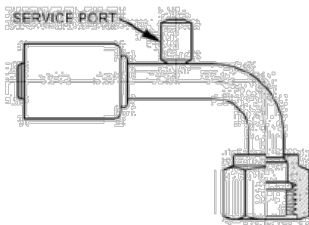

90° Female O-Ring With Switch or Service Port

Standard Barrier	Reduced Barrier	THREAD	F	H	PORT
27-1862	27-2946	5/8"-18	6	6	1/4" R12
27-1295	NS	5/8"-18	6	6	16mm R134a
27-1296	27-2912	3/4"-16	8	8	16mm R134a
27-1297	27-2913	7/8"-14	10	10	13mm R134a
27-1109	27-3059	7/8"-14	10	12	13mm R134a

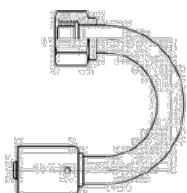

180° Female O-Ring

Standard Barrier	Reduced Barrier	THREAD	F	H	PORT
27-0479		5/8"-18	6	6	-
27-2053	NS	7/8"-14	10	10	-

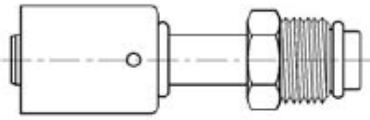

Straight Male O-Ring

Standard Barrier	Reduced Barrier	THREAD	F	H	PORT
27-1365	27-3005	5/8"-18	6	6	-
27-1366	NS	3/4"-18	8	8	-
27-1367	27-2196	7/8-18 "	10	10	-
27-8198	NS	1 1/16-16 "	12	12	-
27-2237	NS	5/8"-18	6	8	-
27-2104	27-8273	7/8-18 "	10	12	-
27-1318		3/4"-18	8	6	-

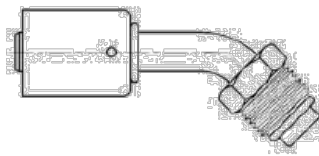

45° Male O-Ring

Standard Barrier	Reduced Barrier	THREAD	F	H	PORT
27-1375	27-2974	5/8"-18	6	6	-
27-1377	27-2914	7/8-18 "	10	10	-
27-3327	NS	5/8"-18	6	8	-

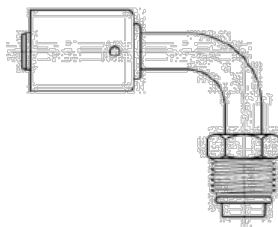

90° Male O-Ring

Standard Barrier	Reduced Barrier	THREAD	F	H	PORT
27-1395	27-2948	5/8"-18	6	6	-
27-2177	NS	3/4"-18	8	8	-
27-1397	27-2915	7/8-18 "	10	10	-
27-8197	NS	1 1/16-16 "	12	12	-
27-3326	NS	5/8"-18	6	8	-
27-1453	27-3060	7/8-18 "	10	12	-
27-2415		7/8-18 "	10	12	13mm R134a

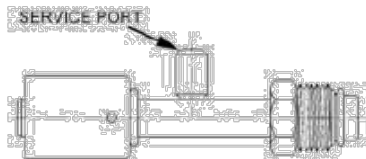

Straight Male O-Ring With Switch or Service Port

Standard Barrier	Reduced Barrier	THREAD	F	H	PORT
27-2099		5/8"-18	6	6	16mm R134a
27-2682		7/8-18 "	10	10	13mm R134a
27-2101		7/8-18 "	10	12	13mm R134a

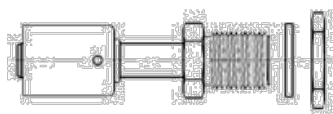

Straight Male Insert O-Ring - Bulkhead

Standard Barrier	Reduced Barrier	THREAD	F	H	PORT
27-0424	27-3057	5/8"-18	6	6	-
27-0425	27-3058	3/4"-16	8	8	-
27-0426	27-3932	7/8"-14	10	10	-

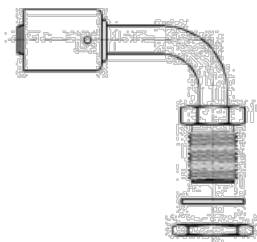

90° Male Insert O-Ring
- Bulkhead

Standard Barrier	Reduced Barrier	THREAD	F	H	PORT
27-0424	27-3057	5/8"-18	6	6	-
27-0425	27-3058	3/4"-16	8	8	-
27-0426	27-3932	7/8"-14	10	10	-

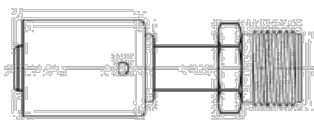

Straight Male Insert O-Ring

Standard Barrier	Reduced Barrier	THREAD	F	H	PORT
27-1392	27-3986	5/8"-18	6	6	-
27-1393	NS	3/4"-16	8	8	-
27-1394	27-3987	7/8"-14	10	10	-
27-2047	NS	1-1/16"-14	12	12	-

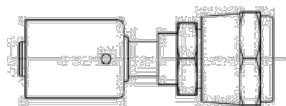

Straight One-Shot Fitting

Standard Barrier	Reduced Barrier	THREAD	F	H	PORT
40-62009-00	NS	5/8"-18	6	6	-

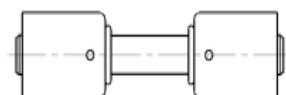

Straight Splicer

Standard Barrier	Reduced Barrier	THREAD	F	H	PORT
NS	27-3884	12 x 12	12	12	-

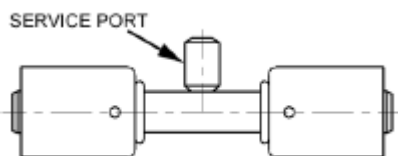

Straight Splicer with
Switch or Service Port

Standard Barrier	Reduced Barrier	THREAD	F	H	PORT
27-1301	27-2955	6 x 6	6	6	16mm R134a
27-1302	27-2970	8 x 8	8	8	16mm R134a
27-1313	NS	10 x 10	10	10	1/4" R12
27-1303	27-2197	10 x 10	10	10	13mm R134a
27-1304	NS	12 x 12	12	12	13mm R134a

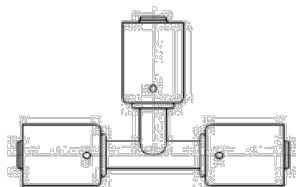

T-Splicer 3 Way Beadlock

Standard Barrier	Reduced Barrier	THREAD	F	H	PORT
27-2823	NS	6 x 6 x 6			-
27-2824	NS	10 x 10 x 10			-
NS	27-3885	12 x 12 x 12			-

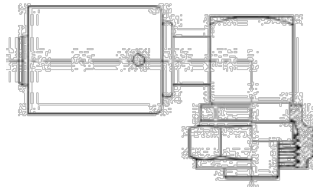

90° Female Tube-O

Standard Barrier	Reduced Barrier	THREAD	F	H	PORT
27-8352	NS	1"-14	FTO	8	-

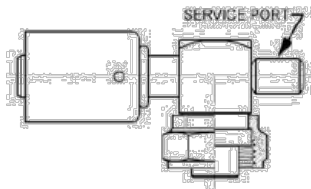

90° Female Tube-O (FTO)
With Switch or Service Port

Standard Barrier	Reduced Barrier	THREAD	F	H	PORT
27-8313	NS	1"-14	FTO	8	16mm R134a
27-8314	NS	1"-14	FTO	12	13mm R134a

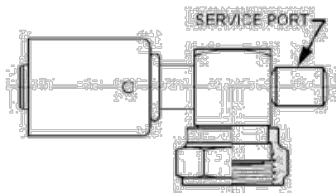

90° Female Rotalok (FRL)
With Switch or Service Port

Standard Barrier	Reduced Barrier	THREAD	F	H	PORT
27-8301	NS	1"-14	FRL	8	16mm R134a
27-8302	NS	1"-14	FRL	10	13mm R134a

Crimp Hose

Part No.	Size	Dimensions				Burst Strength	Crimp OD
		ID		OD			
		Inches	mm	Inches	mm		
27-0020	5/16" 6BH	0.315±0.020	8.0±.05	0.750±0.031	19.1±0.8	2965psi (204 bar)	0.637±.005
27-0021	13/32"8BH	0.420±0.020	10.7±.05	0.906±0.031	23.0±0.8	2490psi (172 bar)	0.790±.005
27-0022	1/2" 10BH	0.510±0.023	13.0±.06	1.000±0.031	25.4±0.8	2320 psi (160 bar)	0.877±.005
27-0023	5/8" 12BH	0.635±0.023	16.1±.06	1.125±0.031	28.6±0.8	2450 psi (169 bar)	1.002±.005

The hose is sold as an assembly including crimped and capped fittings with O-Rings. Hose can also be purchased in bulk per reel. Length varies from 400-650 feet/ reel.



Polychloroprene Tube: The tube is made of a refrigerant resistant polychloroprene tube compound. The tube is compatible with a large number of refrigerants including R12, R134a, R22, R500 and R502. The tube is specially formulated to provide good high and low temperature and resist blistering or delamination associated with rapid pressure changes at elevated temperatures.

Exceeds SAE J2064/J51: The new BH Dayco Barrier Hose exceeds the stringent requirements for the SAE J2064 specification and exceeds the assembly requirement portion of the specification when crimped with the triple bubble dies using the bead lock style couplings. This combination provides you with an OEM design and quality fitting.

PAG Lubricant Compatibility: The Dayco BH Barrier Hose has been tested with all OEM recommended PAG lubricates and has good compatibility with all of them. Fleet testing was done in Australia's outback with PAG lubricants in both new and retro-fitted A/C units. The Dayco BH Barrier Hose is robust designed and field proven.

Performance: Burst Strength

The SAE J2064 burst requirements have increased to 2000 PSI (13.7 MPa) for discharge and liquid line and 1750 PSI (12 MPa) for suction hose. Dayco has selected high strength textile reinforcement to meet these new demands.

Crimp Hose

Part No.	Product Number	Hose Size I.D.		Hose O.D.		Max. Working Pressure		Min. Bend Radius		Min. Burst Pressure		Weight (lbs/foot)
		Inch	mm	Inch	mm	PSI	MPA	Inch	mm	PSI	MPA	
27-8265	4890-06	5/16	7.9	0.56	14.7	500	3.4	1.0	25	2000	13.8	0.09
27-2857	4890-08	13/32	10.3	0.69	17.3	500	3.4	1.5	38	2000	13.8	0.12
27-2956	4890-10	½	12.7	0.75	19.4	500	3.4	2.5	63	2000	13.8	0.13
27-2866	4890-12	5/8	15.9	0.94	23.6	350	2.4	4.0	104	1750	12.1	0.20



Application: Recommended for R134a and most refrigerant blends and compressor lubricants in automotive and heavy-duty truck air conditioning systems where significant reduction in permeation and moisture ingress is desired.

Inner Tube: Chloroprene

Barrier: Nylon

Reinforcement: Single-braid polyester

Cover Compound: Black chlorobutyl

Temperature Range: -40°F to 275°F (-40°C to 135°C)

FlexCLIK FITTING PART NUMBER - KITTED

Fitting Assemblies are sold as a Kit. The FlexCLIK Fitting Kit will include: (1) fitting, (2) FlexCLIK Hose Clamps (Clips) & (1) Cage, all in an MCC pre-printed plastic bag with Bar Code, hose fitting color strip, date code and fitting description (See example below).

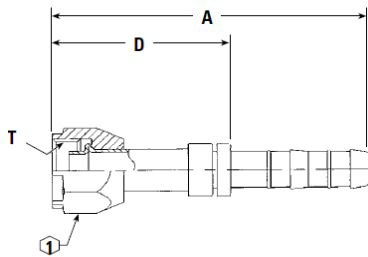

Straight-Female O-Ring
(Short Pilot)

MCC PN	TH'D "T"	Hose	A Ref	D Ref	F Ref	H Ref	⬡
40-64074-50	5/8"-18	6	3.14	1.62	-	-	0.75
40-64074-51	5/8"-18	8	3.16	1.62	-	-	0.75
40-64074-52	3/4"-16	8	3.56	2.02	-	-	0.88
40-64074-53	3/4"-16	10	3.57	2.02	-	-	0.88
40-64074-54	7/8"-14	10	3.63	2.08	-	-	1.06
40-64074-55	7/8"-14	12	3.66	2.08	-	-	1.06
40-64074-56	1-1/16"-14	12	4.25	2.67	-	-	1.25
40-64074-57	7/8"-14	8	3.62	2.08	-	-	0.88
40-64074-58	1-1/16"-14	10	4.25	2.62	-	-	1.25
40-64074-59	7/8"-14	16	3.76	2.08	-	-	1.06
40-64074-60	1-1/16"-14	16	4.35	2.67	-	-	1.25

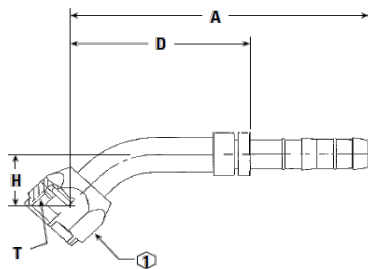

45° Elbow Female
O-Ring (Short Pilot)

MCC PN	TH'D "T"	Hose	A Ref	D Ref	F Ref	H Ref	⬡
40-64106-50	1-1/16"-14	12	5.33	3.75	-	1.47	1.25
40-64106-51	5/8"-18	6	3.60	2.08	-	0.67	0.75
40-64106-52	5/8"-18	8	3.62	2.08	-	0.67	0.75
40-64106-53	3/4"-16	8	3.94	2.40	-	0.73	0.88
40-64106-54	3/4"-16	10	3.95	2.40	-	0.73	0.88
40-64106-55	7/8"-14	10	4.37	2.81	-	1.19	1.06
40-64106-56	7/8"-14	12	4.46	2.88	-	1.25	1.06
40-64106-57	1-1/16"-14	16	5.43	3.15	-	1.47	1.25
40-64106-58	7/8"-14	16	4.56	2.66	-	1.25	1.06

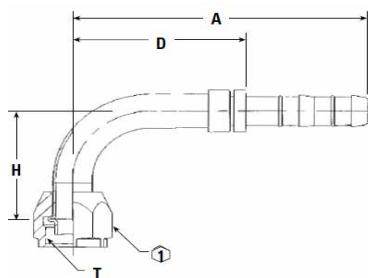

90° Elbow Female
O-Ring (Short Pilot)

MCC PN	TH'D "T"	Hose	A Ref	D Ref	F Ref	H Ref	⬡
40-64075-50	5/8"-18	6	3.32	1.79	-	1.38	0.75
40-64075-51	5/8"-18	8	3.33	1.79	-	1.38	0.75
40-64075-52	3/4"-16	8	3.77	2.33	-	1.62	0.88
40-64075-53	3/4"-16	10	3.78	2.23	-	1.62	0.88
40-64075-54	7/8"-14	10	4.22	2.67	-	1.89	1.06
40-64075-55	7/8"-14	12	4.24	2.67	-	1.89	1.06
40-64075-56	1-1/16"-14	12	4.74	3.16	-	2.56	1.25
40-64075-57	3/4"-16	6	3.86	2.33	-	1.62	0.88
40-64075-58	1-1/16"-14	10	4.76	3.31	-	2.56	1.25
40-64075-59	1-1/16"-14	16	4.84	3.16	-	2.56	1.25
40-64075-60	7/8"-14	16	4.4	2.72	-	1.89	1.06

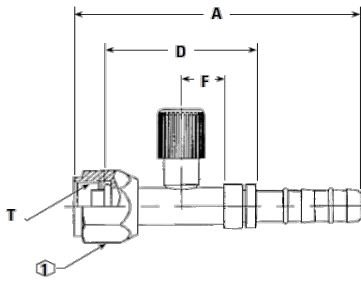

Straight Female O-Ring (Short Pilot) with R134a Low Side Port

MCC PN	TH'D "T"	Hose	A Ref	D Ref	F Ref	H Ref	⊕
40-62157-50	7/8"-14	10	4.24	2.25	0.63	-	1.06
40-62157-51	7/8"-14	12	4.27	2.25	0.63	-	1.06
40-62157-52	1-1/16"-14	12	4.58	2.43	0.54	-	1.25
40-62157-53	1-1/16"-14	16	4.68	2.43	0.54	-	1.25

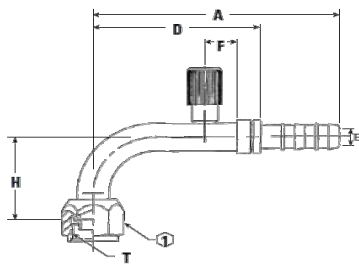

90° Female O-Ring (Short Pilot) with R134a Low Side Port

MCC PN	TH'D "T"	Hose	A Ref	D Ref	F Ref	H Ref	⊕
40-62101-50	7/8"-14	10	4.88	3.33	0.63	1.89	1.06
40-62101-51	1-1/16"-14	12	5.1	3.52	0.63	2.56	1.25
40-62101-55	7/8"-14	12	4.83	3.25	0.63	1.89	1.06
40-62101-56	7/8"-14	16	4.93	3.25	0.63	1.89	1.06
40-62101-57	1-1/16"-14	16	5.2	3.52	0.63	2.56	1.25

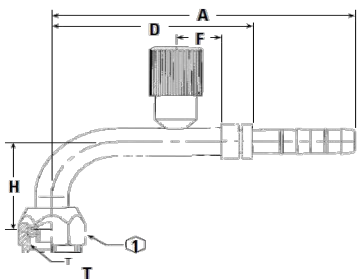

90° Female O-Ring (Short Pilot) With R134a High Side Port

MCC PN	TH'D "T"	Hose	A Ref	D Ref	F Ref	H Ref	⊕
40-62103-50	3/4"-16	8	4.61	3.07	0.69	1.62	0.88
40-62103-51	3/4"-16	10	4.53	2.98	0.69	1.62	0.88

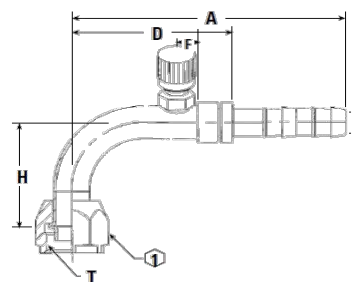

90° Elbow - Female O-Ring (short pilot) with Switch Port (7/16-20 thd)

MCC PN	TH'D "T"	Hose	A Ref	D Ref	F Ref	H Ref	⊕
40-62103-50	3/4"-16	8	4.61	3.07	0.69	1.62	0.88
40-62103-51	3/4"-16	10	4.53	2.98	0.69	1.62	0.88

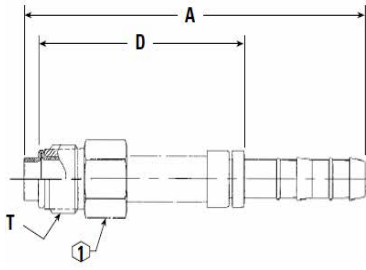

Straight Male O-Ring
(Short Pilot)

MCC PN	TH'D "T"	Hose	A Ref	D Ref	F Ref	H Ref	⊘
40-64081-50	5/8"-18	8	3.43	1.7	-	-	0.62
40-64081-51	7/8"-18	12	3.68	1.92	-	-	0.88
40-64081-52	3/4"-18	8	4.37	2.64	-	-	0.75
40-64081-53	5/8"-18	6	3.41	1.7	-	-	0.62
40-64081-54	7/8"-18	10	3.66	1.92	-	-	0.88
40-64081-55	1-1/16"-16	12	3.68	1.92	-	-	1.06
40-64081-56	7/8"-18	16	4.33	2.47	-	-	0.88
40-64081-57	1-1/16"-16	16	4.28	2.47	-	-	1.06

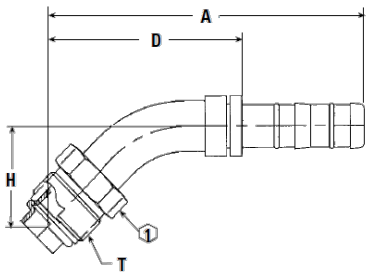

45° Male O-Ring (Short Pilot)

MCC PN	TH'D "T"	Hose	A Ref	D Ref	F Ref	H Ref	⊘
40-62130-50	3/4"-18	8	4.59	2.83	-	1.2	0.75
40-62130-51	7/8"-18	10	4.65	3.1	-	1.46	0.88
40-62130-52	5/8"-18	8	4.01	2.47	-	0.94	0.62
40-62130-53	7/8"-18	12	4.68	3.1	-	1.47	0.88
40-62130-54	1-1/16"-16	12	4.9	3.32	-	1.53	1.06

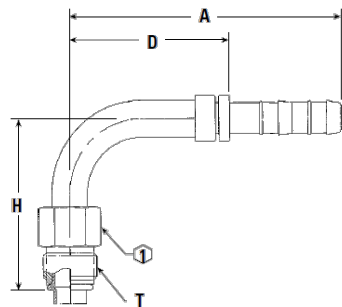

90° Male O-Ring (Short Pilot)

MCC PN	TH'D "T"	Hose	A Ref	D Ref	F Ref	H Ref	⊘
40-64080-50	7/8"-18	12	4.24	2.67	-	2.45	0.88
40-64080-51	5/8"-18	8	3.34	1.8	-	1.77	0.62
40-64080-52	1-1/16"-16	12	4.22	2.64	-	2.79	1.06
40-64080-53	3/4"-18	10	3.78	2.23	-	2.31	0.75
40-64080-55	7/8"-18	12	4.83	3.25	-	1.89	1.06
40-64080-56	5/8"-18	6	3.33	1.8	-	1.77	0.62
40-64080-57	3/4"-18	8	3.77	2.23	-	2.31	0.75
40-64080-58	7/8"-18	10	4.22	2.67	-	2.453	0.88
40-64080-59	1-1/16"-16	10	4.19	2.64	-	2.79	1.06

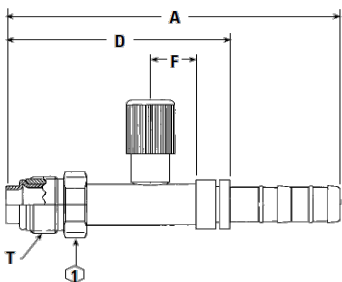

Straight Male O-Ring (short pilot)
with R134a High Side Port

MCC PN	TH'D "T"	Hose	A Ref	D Ref	F Ref	H Ref	⊘
40-64082-50	5/8"-18	6	4.18	2.47	0.63	-	0.62
40-64082-51	3/4"-18	8	4.58	2.85	0.63	-	0.75
40-64082-52	7/8"-18	10	4.34	2.61	0.63	-	0.88

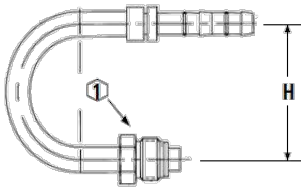

180° Male O-Ring

MCC PN	TH'D "T"	Hose	A Ref	D Ref	F Ref	H Ref	⬡
40-62144-50	5/8"-18	6	-	-	-	2.00	0.625
40-62144-51	7/8"-18	10	-	-	-	3.00	0.88

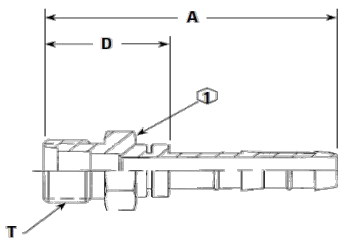

Straight Male Insert O-Ring

MCC PN	TH'D "T"	Hose	A Ref	D Ref	F Ref	H Ref	⬡
40-64089-50	5/8"-18	6	3.36	1.83	-	-	0.69
40-64089-51	3/4"-16	8	2.69	1.15	-	-	0.81
40-64089-52	7/8"-14	10	2.9	1.35	-	-	0.94
40-64089-53	7/8"-14	12	4.11	2.5	-	-	0.94
40-64089-54	1-1/16"-14	12	4.29	2.71	-	-	1.125

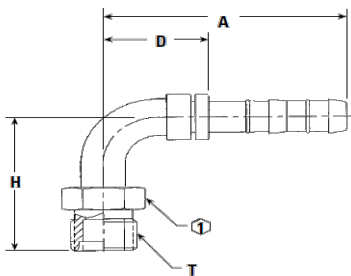

90° Male Insert O-Ring

MCC PN	TH'D "T"	Hose	A Ref	D Ref	F Ref	H Ref	⬡
40-62134-50	5/8"-18	8	2.52	0.48	0.98	1.44	0.5
40-62134-51	3/4"-16	10	2.75	0.56	1.2	1.82	0.63

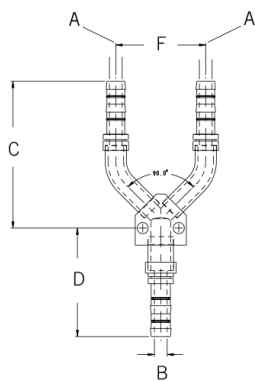

Y Splicer

MCC PN	Description	C Ref	D Ref	F Ref	⬡
40-62127-50	8(A) x 8(A) to 8(B)	4.37	3.24	2.78	-
40-62127-51	10(A) x 10(A to 10(B)	4.30	3.18	2.64	-
40-62127-52	10(A) x 10(A) to 12(B)	4.30	3.11	2.64	-
40-62127-53	12(A) x 12(A) to 12(B)	4.33	3.11	2.64	-
40-62127-54	12(A) x 12(A) to 16(B),	4.33	3.21	2.64	-

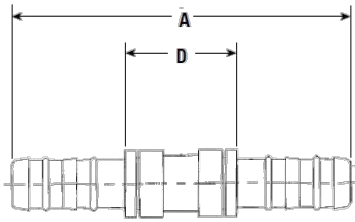

Straight Splicer

MCC PN	TH'D "T"	Hose	A Ref	D Ref	F Ref	H Ref	⬡
40-62128-52	-	6	4.63	1.58	-	-	-
40-62128-53	-	8	4.76	1.68	-	-	-
40-62128-54	-	10	5.68	2.58	-	-	-
40-62128-55	-	12	4.72	1.57	-	-	-
40-62128-56	-	16	5.18	1.82	-	-	-

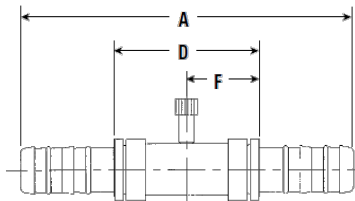

Splicer With Switchport
7/16"-20 Thread

MCC PN	TH'D "T"	Hose	A Ref	D Ref	F Ref	H Ref	⬡
40-62112-50	-	6	5.41	2.36	1.18	-	-
40-62112-51	-	8	5.61	2.52	1.26	-	-
40-62112-52	-	10	5.54	2.44	1.22	-	-
40-62212-53	-	12	5.6	2.44	1.22	-	-
40-62212-54	-	16	6.79	3.44	1.72	-	-

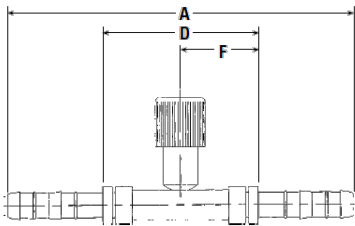

Splicer With R134a
Low Side Port

MCC PN	TH'D "T"	Hose	A Ref	D Ref	F Ref	H Ref	⬡
40-64115-50	-	10	5.54	2.44	1.22	-	-
40-64115-51	-	12	5.60	2.44	1.22	-	-
40-64115-52	-	16	6.79	3.44	1.72	-	-

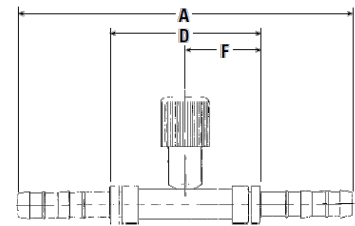

Splicer With High
Side R134a Port

MCC PN	TH'D "T"	Hose	A Ref	D Ref	F Ref	H Ref	⬡
40-64095-51	-	6	5.41	2.36	1.18	-	-
40-64095-52	-	8	5.61	2.52	1.26	-	-
40-64095-50	-	10	5.62	2.52	1.26	-	-

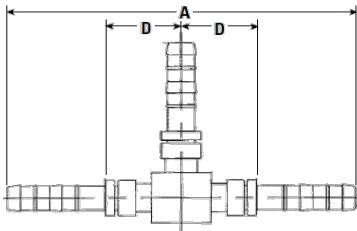

"T" Splicer -
3 Hose Connector

MCC PN	TH'D "T"	Hose	A Ref	D Ref	F Ref	H Ref	⬡
40-62102-50	-	8	5.48	2.40	-	-	-
40-62102-51	-	10	5.62	2.52	-	-	-
40-62102-52	-	12	5.67	2.52	-	-	-

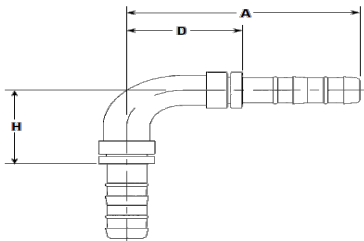

90° Splicer

MCC PN	TH'D "T"	Hose	A Ref	D Ref	F Ref	H Ref	⬡
40-62131-50	-	8	2.98	1.43	-	2.98	-
40-62131-51	-	10	3.08	1.53	-	3.08	-
40-62131-52	-	12	3.68	2.11	-	3.68	-

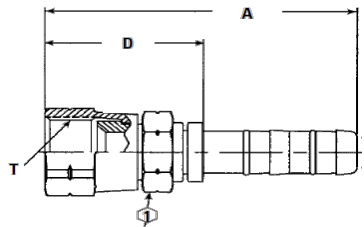

Female SAE 45° Flares

MCC PN	TH'D "T"	Hose	A Ref	D Ref	F Ref	H Ref	⬡
40-64084-50	3/4"-18	8	2.96	1.42	-	-	0.69
40-64084-51	5/8"-18	8	3.14	1.62	-	-	0.75
40-64084-52	1-1/16"-16	12	3.20	1.62	-	-	1.25
40-64084-53	3/4"-18	10	3.56	2.02	-	-	0.88
40-64084-54	7/8"-18	10	3.63	2.08	-	-	1.00
40-64084-55	5/8"-18	6	2.88	1.35	-	-	0.56
40-64084-56	7/8"-18	12	3.66	2.08	-	-	1.00

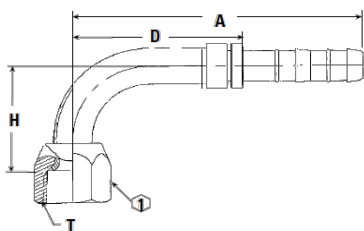

90° Female SAE 45° Flare
To FlexCLIK Hose

MCC PN	TH'D "T"	Hose	A Ref	D Ref	F Ref	H Ref	⬡
40-64073-50	5/8"-18	6	2.51	0.98	-	0.85	0.75
40-64073-51	5/8"-18	8	2.52	0.98	-	0.85	0.75
40-64073-52	3/4"-16"	8	2.74	1.2	-	1.09	0.88
40-64073-53	7/8"-14"	10	3.09	1.54	-	1.19	1.00
40-64073-54	7/8"-14"	12	3.09	1.54	-	1.19	1.00
40-64073-55	1-1/16"-14"	12	3.68	2.11	-	1.80	1.25

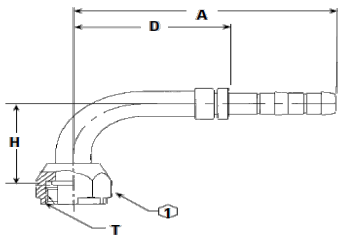

90° Female O-Ring (long pilot) Metric Thread

MCC PN	TH'D "T"	Hose	A Ref	D Ref	F Ref	H Ref	
40-62135-50	M20 x 1.5	10	3.78	2.23	-	1.62	0.94
40-62135-51	M27 x 2	12	4.74	3.16	-	2.56	1.25

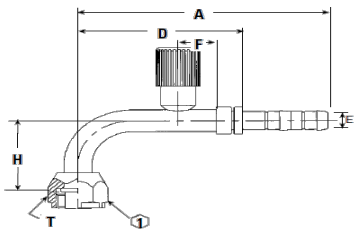

90° Female O-Ring (long pilot) Metric Thread With High-Side Port

MCC PN	TH'D "T"	Hose	A Ref	D Ref	F Ref	H Ref	
40-62135-52	M20 x 1.5	8	4.52	2.98	0.69	1.62	0.94

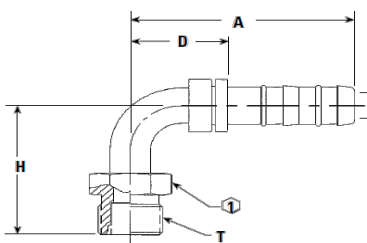

90° Male O-Ring (rigid) Metric Thread

MCC PN	TH'D "T"	Hose	A Ref	D Ref	F Ref	H Ref	
40-62133-50	M20 x 1.5	10	2.75	1.2	-	1.82	0.88

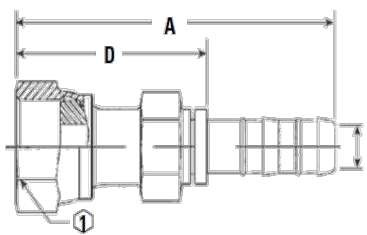

Straight O-Ring Seal Female Swivel

MCC PN	TH'D "T"	Hose	A Ref	D Ref	F Ref	H Ref	
40-62152-50	1-1/16"-16	6	2.95	1.43	-	-	22mm
40-62152-51	1-3/16"-16	8	3.17	1.62	-	-	24mm
40-62152-52	1"-14	10	3.33	1.78	-	-	30mm
40-62152-54	1"-14	12	3.32	1.74	-	-	30mm
40-62152-55	1-3/16"-12	12	3.38	1.80	-	-	36mm

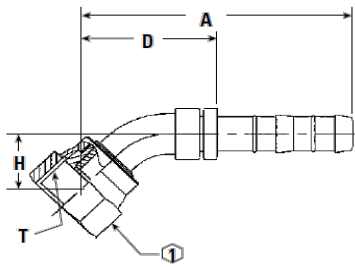

45° O-Ring Seal Female Swivel

MCC PN	TH'D "T"	Hose	A Ref	D Ref	F Ref	H Ref	⬡
40-62151-50	11/16"-16	6	2.65	1.12	-	0.44	0.81
40-62151-51	13/16"-16	8	3.02	1.47	-	0.59	0.94
40-62151-52	1"-14	10	3.22	1.67	-	0.7	1.13
40-62151-54	1"-14	8	3.5	1.96	-	0.68	1.18
40-62151-55	1-3/16"-12	12	4.23	2.65	-	0.83	1.42
40-62151-56	1-3/16"-16	10	3.02	1.47	-	0.59	0.94
40-62151-57	1-7/16"-12	16	4.62	2.94	-	0.94	1.61
40-62151-58	1"-14	10	3.76	2.21	-	0.68	1.18

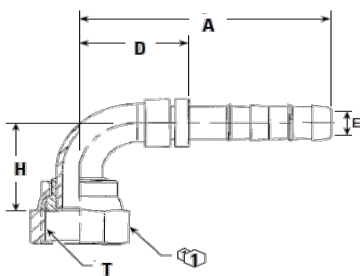

90° O-Ring Seal Female Swivel

MCC PN	TH'D "T"	Hose	A Ref	D Ref	F Ref	H Ref	⬡
40-64094-50	1"-14	10	3.09	1.53	-	1.27	1.12
40-64094-51	11/16"-16	6	2.50	0.98	-	0.91	0.81
40-64094-52	13/16"-16	8	2.74	1.2	-	1.15	0.94
40-64094-53	1-3/16"-12	12	3.36	1.78	-	1.9	1.38
40-64094-54	9/16"-18	6	2.44	0.92	-	0.82	0.69
40-64094-55	1"-14	12	3.11	1.53	-	1.78	1.13
40-64094-56	13/16"-16	6	2.66	1.10	-	1.15	0.94
40-64094-57	1"-14	16	3.3	1.62	-	1.78	1.12
40-64094-58	1"-14	12	3.67	2.10	-	1.54	1.18
40-64094-59	1-7/16"-12	16	3.71	2.04	-	2.22	1.63
40-64094-60	13/16"-16	16	3.46	1.78	-	1.90	1.38
40-64094-61	9/16"-18	10	2.75	1.20	-	1.15	0.94

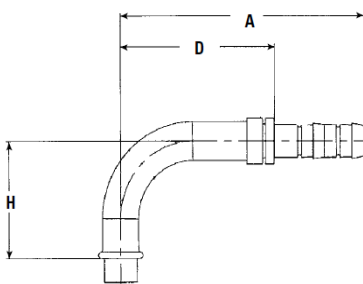

90° Pilot Connection (long pilot)

MCC PN	TH'D "T"	Hose	A Ref	D Ref	F Ref	H Ref	⬡
40-62132-50	6	8	3.23	1.69	-	1.38	0.75
40-62132-51	10	12	4.25	2.67	-	1.89	1.25

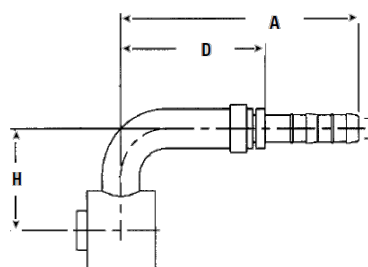

90° GM Block Style

MCC PN	TH'D "T"	Hose	A Ref	D Ref	F Ref	H Ref	⬡
40-62136-50	-	10	3.83	2.28	-	2.31	-
40-62136-51	-	12	3.86	2.28	-	2.38	-

FlexClik Hose - Clamps - Cages & O-Rings

FlexCLIK Hose

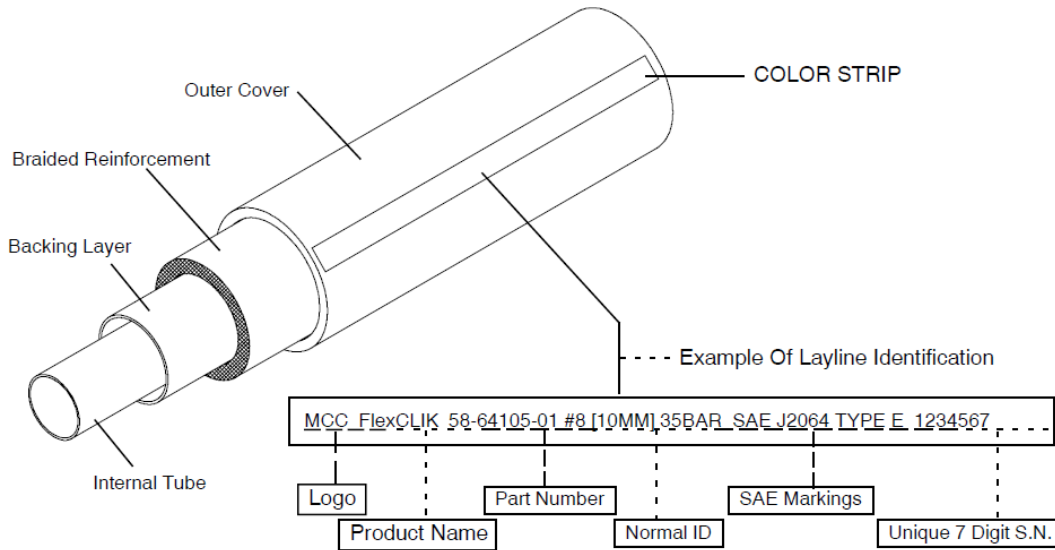

MCC PN	Dash Size	Description
58-64105-90	6	Black, 5/16" 50 Foot (8.1 mm ID x 15.2 mm OD)
58-64105-13	8	Green, 13/32" 50 Foot (10.7 mm ID x 18.2mm OD)
58-64105-24	10	Red, 1/2" 50 Foot (13.2 mm ID x 20.3 mm OD)
58-64105-34	12	Blue, 5/8" 50 Foot (16.3 mm ID x 25.1 mm OD)
58-64105-44	16	Blue, 7/8" 50Foot (16.3 mm ID x 25.1 mm OD)

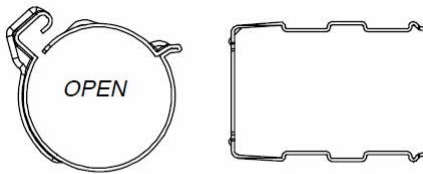

44-64008-50,-51,-52,-53

MCC PN	Dash Size	Description
44-64008-50	6	FlexCLIK Clamp/Cage Kit
44-64008-51	8	FlexCLIK Clamp/Cage Kit
44-64008-52	10	FlexCLIK Clamp/Cage Kit
44-64008-53	12	FlexCLIK Clamp/Cage Kit

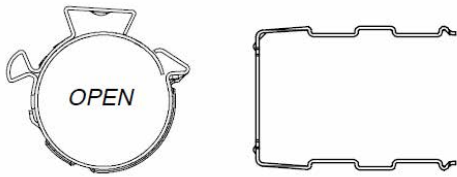

44-64008-54

MCC PN	Dash Size	Description
44-64008-54	16	FlexCLIK Clamp/Cage Kit

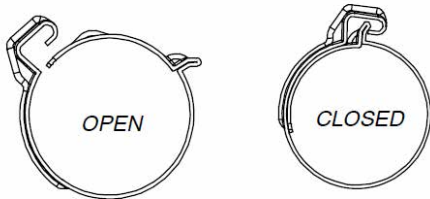

44-64009-00,-01,-02, -03

MCC PN	Dash Size	Description
44-64009-00	6	FlexCLIK Clamp, CLIC 86 N 150
44-64009-01	8	FlexCLIK Clamp, CLIC 86 N 175
44-64009-02	10	FlexCLIK Clamp, CLIC 86 N 200
44-64009-03	12	FlexCLIK Clamp, CLIC 86 N 245

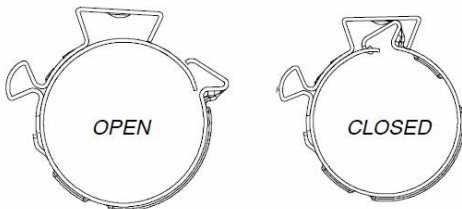

44-64009-04

MCC PN	Dash Size	Description
44-64009-04	16	FlexCLIK Clamp, CLIC E N 285

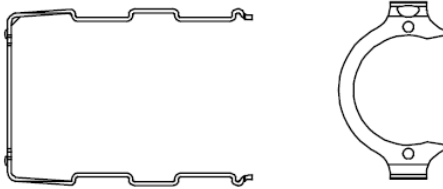

MCC PN	Dash Size	Description
44-64008-00	6	FlexCLIK Clamp Cage
44-64008-01	8	FlexCLIK Clamp Cage
44-64008-02	10	FlexCLIK Clamp Cage
44-64008-03	12	FlexCLIK Clamp Cage
44-64008-04	16	FlexCLIK Clamp Cage

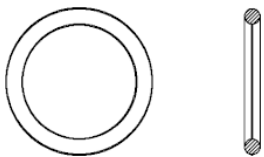

MCC PN	Dash Size	Description
42-62157-00	4	FlexCLIK O-Ring Nipple, Hose End
42-62157-01	6	FlexCLIK O-Ring Nipple, Hose End
42-62157-02	8	FlexCLIK O-Ring Nipple, Hose End
42-62157-03	10	FlexCLIK O-Ring Nipple, Hose End
42-62157-04	12	FlexCLIK O-Ring Nipple, Hose End
42-62157-05	16	FlexCLIK O-Ring Nipple, Hose End

FlexCLIK & Quick-CLICK Cross Reference

FlexCLIK KITTED PN	FITTING DESCRIPTION	Quick-CLICK
40-62101-50	90°, #10 FOR X #10 Hose, W/LSA, FlexCLIK	40-62023-01
40-62101-51	90°, #12 FOR X #12 Hose, W/LSA, FlexCLIK	N/A
40-62101-55	90°, #10 FOR X #12 Hose, W/LSA, FlexCLIK	40-62023-00
40-62101-56	90°, #10 FOR X #16 Hose, W/LSA, FlexCLIK	N/A
40-62101-57	90°, #12 FOR X #16 Hose, W/LSA, FlexCLIK	N/A
40-62102-50	TEE, #8 X #8 X #8 Hose, FlexCLIK	40-62012-00
40-62102-51	TEE, #10 X #10 X #10 Hose, FlexCLIK	40-62012-02
40-62102-52	TEE, #12 X #12 X #12 Hose, FlexCLIK	40-62012-01
40-62103-50	90°, #8 FOR X #10 Hose, W/HSA, FlexCLIK	40-62022-00
40-62103-51	90°, #8 FOR X #8 Hose, W/HSA, FlexCLIK	40-62022-01
40-62103-52	90°, #8 FOR X #10 Hose, W/HSA, FlexCLIK	N/A
40-62112-50	Splicer, #6 Hose, FLX, With 1/4 Inch Schrader	40-60081-02
40-62112-51	Splicer, #8 Hose, FLX, With 1/4 Inch Schrader	40-60081-03
40-62112-52	Splicer, #10 Hose, FLX, With 1/4 Inch Schrader	40-60081-04
40-62128-52	Splicer, #6 Hose, FlexCLIK	N/A
40-62128-53	Splicer, #8 Hose, FlexCLIK	N/A
40-62128-54	Splicer, #10 Hose, FlexCLIK	N/A
40-62128-55	Splicer, #12 Hose, FlexCLIK	N/A
40-62128-56	Splicer, #16 Hose, FlexCLIK	N/A
40-62130-50	Y, 8(A)x8(B)-8(B), FlexCLIK	40-60084-06
40-62130-51	Y, 10(A)x10(B)-10(B), FlexCLIK	40-60084-05
40-62130-52	Y, 10(A)x10(B)-12(B), FlexCLIK	N/A
40-62130-53	Y, 12(A)x12(B)-12(B), FlexCLIK	N/A
40-62130-54	Y, 12(A)x12(B)-16(B), FlexCLIK	N/A
40-62131-50	90°, Splicer, #8 Hose, FlexCLIK	40-60137-03
40-62131-51	90°, Splicer, #10 Hose, FlexCLIK	40-60137-04
40-62131-52	90°, Splicer, #12 Hose, FlexCLIK	40-60137-05
40-62132-50	90°, #6 POR, #8 Hose, FlexCLIK	N/A
40-62132-51	90°, #10 POR, #12 Hose, FlexCLIK	N/A
40-62133-50	90°, Metric, MOR X #10 Hose, FlexCLIK	N/A
40-62134-50	90°, #6 MORX #8 Hose, FlexCLIK	N/A
40-62134-51	90°, #8 MORX #10 Hose, FlexCLIK	N/A
40-62135-50	90°, M20x1.5, FOR X #10 Hose, FlexCLIK	N/A
40-62135-51	90°, M27x2.0, FOR X #12 Hose, FlexCLIK	N/A
40-62135-52	90°, M20x1.5 W/HSP, FOR X #8 Hose, FlexCLIK	N/A
40-62136-50	90°, GMBlock X #10 Hose, FlexCLIK	40-62088-00
40-62136-51	90°, GMBlock X #12 Hose, FlexCLIK	40-62089-00
40-62144-50	180°, #6 MOR X #8 Hose, FlexCLIK	N/A
40-62144-51	180°, #10 MOR X #12 Hose, FlexCLIK	N/A

FlexCLIK KITTED PN	FITTING DESCRIPTION	Quick-CLICK
40-62151-50	45°, #6 FORS X #6Hose, FlexCLIK	N/A
40-62151-51	45°, #8 FORS X #8Hose, FlexCLIK	N/A
40-62151-52	45°, #10 FORS X #10Hose, FlexCLIK	N/A
40-62151-54	45°, #10 FORS X #10Hose, FlexCLIK	N/A
40-62151-55	45°, #12 FORS X #12Hose, FlexCLIK	N/A
40-62151-56	45°, #8 FORS X #10Hose, FlexCLIK	N/A
40-62151-57	45°, #16 FORS X #16Hose, FlexCLIK	N/A
40-62151-58	45°, #10 FORS X #10Hose, FlexCLIK	N/A
40-62152-50	Straight, #6 FORS X #6Hose, FlexCLIK	N/A
40-62152-51	Straight, #8 FORS X #8Hose, FlexCLIK	N/A
40-62152-52	Straight, #10 FORS X #10Hose, FlexCLIK	N/A
40-62152-53	Straight, #12 FORS X #12Hose, FlexCLIK	N/A
40-62152-54	Straight, #12 FORS X #12Hose, FlexCLIK	N/A
40-62152-55	Straight, #10 FORS X #12Hose, FlexCLIK	N/A
40-62157-50	Straight, #10 FOR X #10Hose, FlexCLIK	N/A
40-62157-51	Straight, #10 FOR X #12Hose, FlexCLIK	N/A
40-62157-52	Straight, #12 FOR X #12Hose, FlexCLIK	N/A
40-62157-53	Straight, #12 FOR X #16Hose, FlexCLIK	N/A
40-62212-53	Splicer, #12 Hose, FLX, With 1/4 Inch Schrader	40-60081-05
40-62212-54	Splicer, #16 Hose, FLX, With 1/4 Inch Schrader	N/A
40-64073-50	90°, #6 FFL X #6 Hose, FlexCLIK	40-60079-02
40-64073-51	90°, #6 FFL X #8 Hose, FlexCLIK	N/A
40-64073-52	90°, #8 FFL X #8 Hose, FlexCLIK	40-60079-03
40-64073-53	90°, #10 FFL X #10 Hose, FlexCLIK	40-60079-04
40-64073-54	90°, #10 FFL X #12 Hose, FlexCLIK	40-60079-07
40-64073-55	90°, #12 FFL X #12 Hose, FlexCLIK	40-60079-05
40-64074-50	#6 Straight, FOR X #6 Hose, FlexCLIK	40-60060-02
40-64074-51	#6 Straight, FOR X #8 Hose, FlexCLIK	40-60060-08
40-64074-52	#8 Straight, FOR X #8 Hose, FlexCLIK	40-60060-03
40-64074-53	#8 Straight, FOR X #10 Hose, FlexCLIK	40-60060-06
40-64074-54	#10 Straight, FOR X #10 Hose, FlexCLIK	40-60060-04
40-64074-55	#10 Straight, FOR X #12 Hose, FlexCLIK	40-60060-07
40-64074-56	#12 Straight, FOR X #12 Hose, FlexCLIK	40-60060-05
40-64074-57	#10 Straight, FOR X #8 Hose, FlexCLIK	N/A
40-64074-58	#12 Straight, FOR X #10 Hose, FlexCLIK	N/A
40-64074-59	#10 Straight, FOR X #16 Hose, FlexCLIK	N/A
40-64074-60	#12 Straight, FOR X #16 Hose, FlexCLIK	N/A
40-64075-50	90°, #6FOR X #6Hose, FlexCLIK	40-60061-02
40-64075-51	90°, #6FOR X #8Hose, FlexCLIK	40-60061-08

FlexCLIK KITTED PN	FITTING DESCRIPTION	Quick-CLICK
40-64075-52	90°, #8FOR X #8Hose, FlexCLIK	40-60061-03
40-64075-53	90°, #8 FOR X#10 Hose, FlexCLIK	40-60061-06
40-64075-54	90°, #10 FOR X #10 Hose, FlexCLIK	40-60061-04
40-64075-55	90°, #10 FOR X #12 Hose, FlexCLIK	40-60061-07
40-64075-56	90°, #12 FOR X #12 Hose, FlexCLIK	40-60061-05
40-64075-57	90°, #8FOR X #6Hose, FlexCLIK	N/A
40-64075-58	90°, #12 FOR X #10 Hose, FlexCLIK	N/A
40-64075-59	90°, #12 FOR X #16 Hose, FlexCLIK	N/A
40-64075-60	90°, #16 FOR X #16 Hose, FlexCLIK	N/A
40-64080-50	90°, #10 MOR X #12 Hose, FlexCLIK	40-60083-07
40-64080-51	90°, #6MOR X #8Hose, FlexCLIK	40-60083-08
40-64080-52	90°, #12 MOR X #12 Hose, FlexCLIK	N/A
40-64080-53	90°, #8 MOR X#10 Hose, FlexCLIK	N/A
40-64080-55	90°, #6MOR X #6Hose, FlexCLIK	40-60083-02
40-64080-56	90°, #8MOR X #8Hose, FlexCLIK	40-60083-03
40-64080-57	90°, #10 MOR X #12 Hose, FlexCLIK	40-60083-04
40-64080-58	90°, #12 MOR X #10 Hose, FlexCLIK	N/A
40-64080-59	90°, #12 MOR X #10 Hose, FlexCLIK	N/A
40-64081-50	Straight, #6MOR X #8Hose, FlexCLIK	40-60051-08
40-64081-51	Straight, #10 MOR X #12 Hose, FlexCLIK	40-60051-07
40-64081-52	Straight, #8MOR X #8Hose, FlexCLIK	40-60051-03
40-64081-53	Straight, #6MOR X #6Hose, FlexCLIK	40-60051-02
40-64081-54	Straight, #10 MOR X #10 Hose, FlexCLIK	40-60051-04
40-64081-55	Straight, #12 MOR X #12 Hose, FlexCLIK	N/A
40-64081-56	Straight, #10 MOR X #16 Hose, FlexCLIK	N/A
40-64081-57	Straight, #12 MOR X #16 Hose, FlexCLIK	N/A
40-64082-50	Straight, #10 MOR X #10 Hose, HS, FlexCLIK	N/A
40-64082-51	Straight, #6MOR X #6Hose, HS, FlexCLIK	N/A
40-64082-52	Straight, #8MOR X #8Hose, HS, FlexCLIK	N/A
40-64084-50	Straight, #8 FFL X #8 Hose, FlexCLIK	40-60078-03
40-64084-51	Straight, #6 FFL X #8 Hose, FlexCLIK	N/A
40-64084-52	Straight, #12 FFL X #12 Hose, FlexCLIK	40-60078-05
40-64084-53	Straight, #8 FFL X#10 Hose, FlexCLIK	40-60078-06
40-64084-54	Straight, #10 FF X #10 Hose, FlexCLIK	40-60078-04
40-64084-55	Straight, #6 FFL X #6 Hose, FlexCLIK	40-60078-02
40-64084-56	Straight, #10 FFL X #12 Hose, FlexCLIK	40-60078-07
40-64089-50	Straight, #6MIO X #6Hose, FlexCLIK	N/A
40-64089-51	Straight, #8MIO X #8Hose, FlexCLIK	N/A
40-64089-52	Straight, #10 MIO X #10 Hose, FlexCLIK	N/A

FlexCLIK KITTED PN	FITTING DESCRIPTION	Quick-CLICK
40-64089-53	Straight, #10 MIO X #12 Hose, FlexCLIK	N/A
40-64089-54	Straight, #12 MIO X #12 Hose, FlexCLIK	N/A
40-64092-50	90°, #10 FOR X #10 Hose W/1/4 Schrader, FLK	N/A
40-64092-51	90°, #12 FOR X #12 Hose W/1/4 Schrader, FLK	N/A
40-64094-50	90°, #10 F.Swivel, ORS X #10 Hose, FlexCLIK	40-60048-04
40-64094-51	90°, #6 F.Swivel, ORS X #6 Hose, FlexCLIK	40-60048-02
40-64094-52	90°, #8 F.Swivel, ORS X #8 Hose, FlexCLIK	40-60048-03
40-64094-53	90°, #12 F.Swivel, ORS X #12 Hose, FlexCLIK	40-60048-05
40-64094-54	90°, #4 F.Swivel, ORS X #6 Hose, FlexCLIK	40-60048-01
40-64094-55	90°, #10 F.Swivel, ORS X #12 Hose, FlexCLIK	40-60048-07
40-64094-56	90°, #8 F.Swivel, ORS X #6 Hose, FlexCLIK	40-60048-10
40-64094-57	90°, #10 F.Swivel, ORS X #16 Hose, FlexCLIK	N/A
40-64094-58	90°, #10 F.Swivel, ORS X #12 Hose, FlexCLIK	N/A
40-64094-59	90°, #16 F.Swivel, ORS X #16 Hose, FlexCLIK	N/A
40-64094-60	90°, #10 F.Swivel, ORS X #16 Hose, FlexCLIK	N/A
40-64094-61	90°, #18 F.Swivel, ORS X #10 Hose, FlexCLIK	N/A
40-64095-50	Splicer, #10 Hose, FlexCLIK, W/High Side Access	40-60059-04
40-64095-51	Splicer, #6 Hose, FlexCLIK, W/High Side Access	40-60059-02
40-64095-52	Splicer, #8 Hose, FlexCLIK, W/High Side Access	40-60059-03
40-64106-50	45°, #12 FOR X #12 Hose, FlexCLIK	40-60050-05
40-64106-51	45°, #6FOR X #6Hose, FlexCLIK	40-60050-02
40-64106-52	45°, #6FOR X #8Hose, FlexCLIK	40-60050-08
40-64106-52	45°, #6FOR X #8Hose, FlexCLIK	40-60050-08
40-64106-53	45°, #8FOR X #8Hose, FlexCLIK	40-60050-03
40-64106-54	45°, #8 FOR X #10 Hose, FlexCLIK	40-60050-06
40-64106-55	45°, #10 FOR X #10 Hose, FlexCLIK	40-60050-04
40-64106-56	45°, #10 FOR X #12 Hose, FlexCLIK	40-60050-07
40-64106-57	45°, #12 FOR X #16 Hose, FlexCLIK	N/A
40-64106-58	45°, #10 FOR X #16 Hose, FlexCLIK	N/A
40-64115-50	Splicer, #10 Hose, FlexCLIK, W/Low Side Access	40-60058-04
40-64115-51	Splicer, #12 Hose, FlexCLIK, W/Low Side Access	40-60058-05
40-64115-52	Splicer, #16 Hose, FlexCLIK, W/Low Side Access	40-64115-52



O-Ring Pilot Thread Sizes

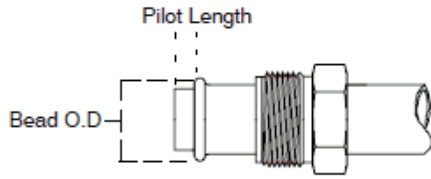

Male O-Ring

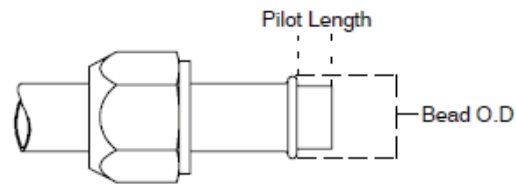

Female O-Ring

Male Thread O.D. (Inch)					Female Thread I.D. (Inch)		
Inch Size	Dash Size	Thread	Fraction	Decimal	Thread	Fraction	Decimal
3/8	6	5/8-18	5/8	.62	5/8-18	9/16	.57
1/2	8	3/4-18	3/4	.75	3/4-16	11/16	.69
5/8	10	7/8-18	7/8	.87	7/8-14	13/16	.81
3/4	12	1-1/16-16	1-1/16	1.06	11/16-14	1	.99

LongPilot				ShortPilot	
Inch Size	Nominal Tube Size	Bead O.D. (Inch)	Pilot Length	Bead O.D. (Inch)	Pilot Length
3/8	6	.52	.28	.52	.19
1/2	8	.64	.39	.64	.19
5/8	10	.77	.39	.77	.19
3/4	12	.91	.39	.91	.19

Note: This connection is common to air conditioning systems, both in vehicle and commercial applications. Both the male and female halves of the connections have a pilot, either long or short. The seal takes place by compressing an O-Ring adjacent to the bead of the tube. The threads hold the connection together mechanically.

Hose Pipe Insulation & Sleeves

Hose Pipe Insulation

Hose / pipe insulation is used to insulate heater and refrigerant hose. Sold in multiples of 6 feet.

- 28-0077 Hose/ pipe insulation 1 1/8" ID x 3/8" wall
Use for 5/8" HD heater hose and #10 refrigerant hose
- 28-0136 Hose/ pipe insulation 7/8" ID x 1/2" wall Use for 5/8" standard heater hose

Polyurethane Sleeves

Polyurethane sleeve is used for hose protection in very difficult environments. This product is used extensively in the mining industry. Sold in multiples of 12 feet.

- 27-0806 Polyurethane sleeve for refrigerant hose #6
- 27-0807 Polyurethane sleeve for refrigerant hose #10